

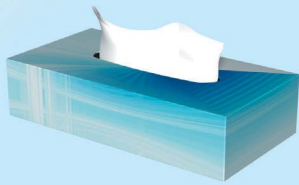

# Tsubaki Power and Performance for the Toiletry Manufacturing Industry



# What are toiletries?



## Sanitary products

Facial tissue, disposable diapers, etc.



## Home care products

Toilet paper, fragrances, etc.



## Personal care products

Cotton swabs, disposable warmers, etc.





Toiletries are daily necessities sold at drugstores and other retailers.

Various Tsubaki products are used in the manufacturing process of toiletries.

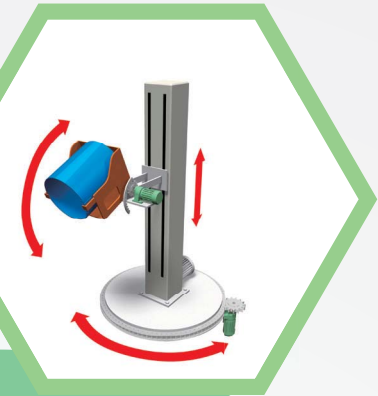

### Cosmetics

Shampoo, face lotion, antiperspirant, etc.



2  
Agitation

### Laundry products

Detergent, soap, etc.

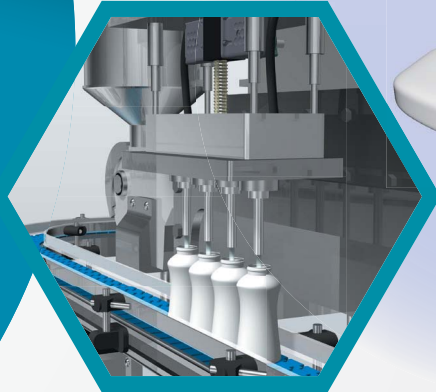

3  
Filling

4  
Transport

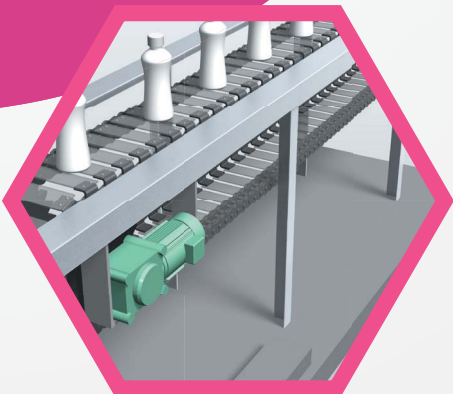

### Oral care products

Toothpaste, toothbrushes, etc.





# Lifters

## Pin Gear Drive Unit

The pin gear drive unit is optimal for container rotating and inverting mechanisms. It offers more flexible installation than a gear. In addition, the split segment system enables production at various sizes for limitless design possibilities.

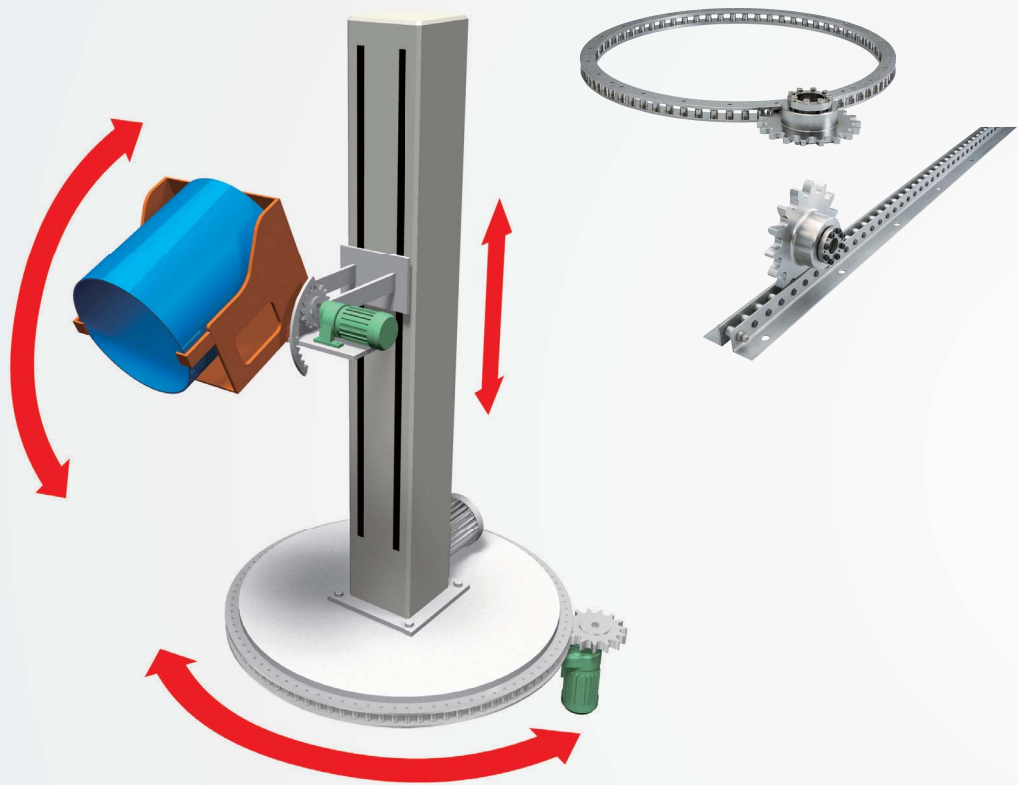
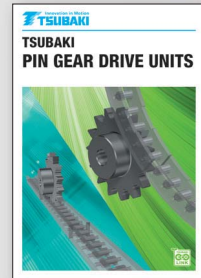

## Zip Master

This revolutionary lifter uses a Zip Chain of two interlocked chains. The guide is built in for high-speed, high-frequency operation.

The compact, high-lift design revolutionizes operations on the production floor.



## Troi Drive

This reducer uses a drum-shaped troidal worm gear to achieve high transmission capacity and high efficiency. Smooth rotation with self-locking feature for low load repulsion and reduced motor issues.

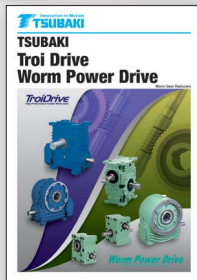

## Shock Monitor

This is a power-monitoring controller. It monitors for changes in viscosity (micro loads) during agitation, and enables switching of alerts and RPM. In addition, it protects agitating blades from overloads.

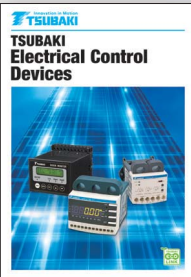



## ZIP CHAIN ACTUATOR

The filling nozzle can be raised or lowered using the Zip Chain Actuator to save space.

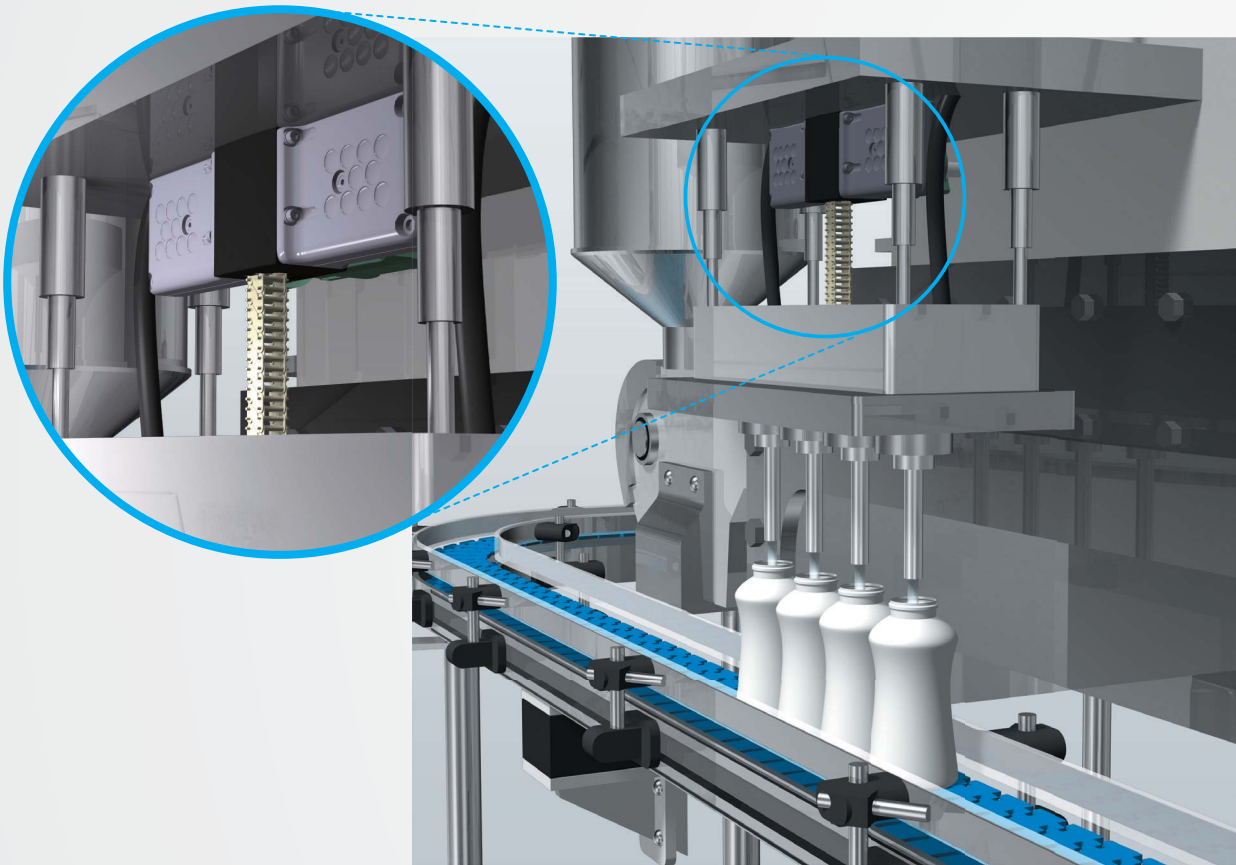

## Plastic Top Chain

Made of excellent self-lubricating plastic, this chain enables operation without lubrication. It is also lightweight and can be operated at low noise.

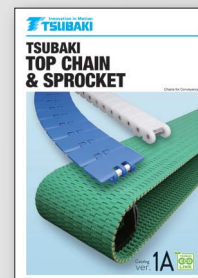



## Small Size Gear Motor

Choose the optimal hypoid gear, worm gear, or helical gear.

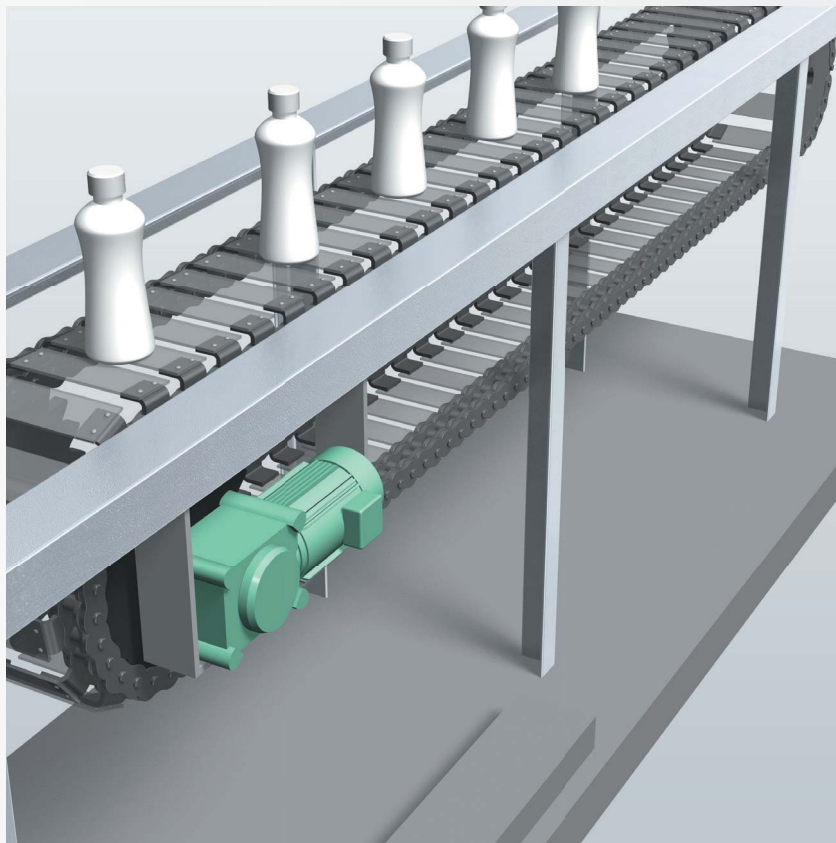
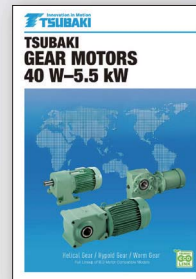

## Lube-free Small Size Conveyor Chain

This product meets customer demand for a lube-free, long-life design and realizes cost reduction.





# Packaging Machines

## Coupling

Choose the best coupling for the application.

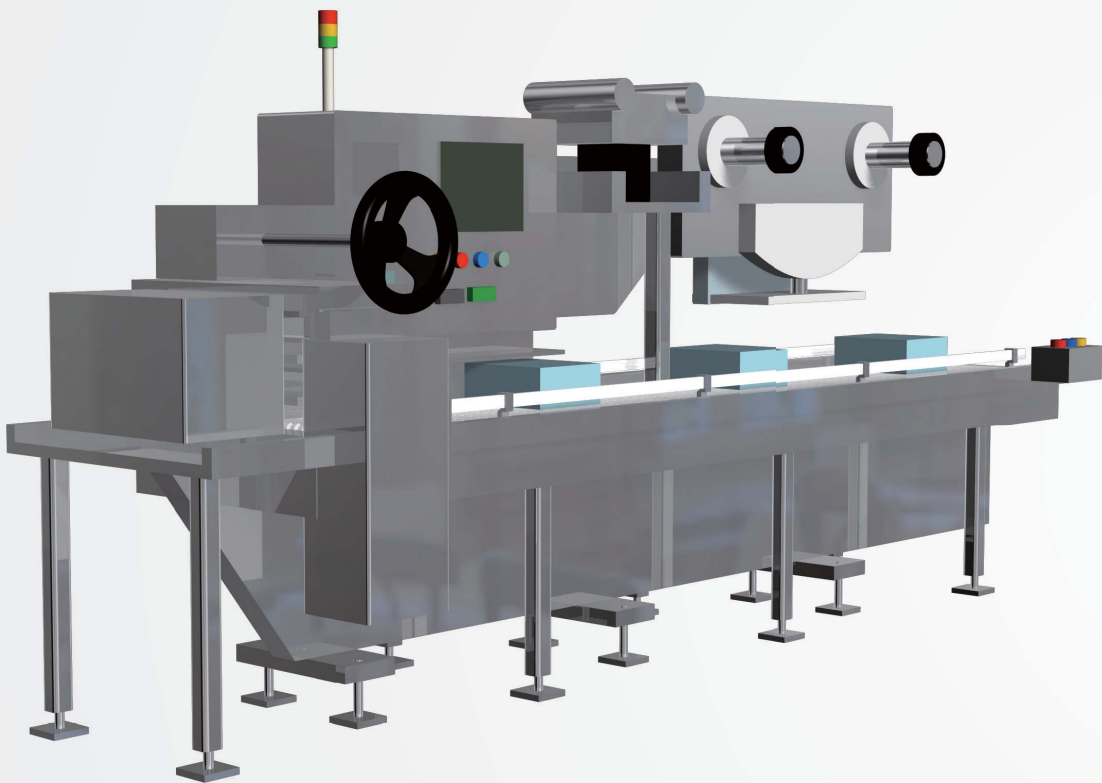

## Plastic Rail Low-Friction Wear-Resistant Specifications (PLF)

Plastic rails reduce the coefficient of friction with objects being conveyed and have superb wear resistance, providing optimal conditions to prevent damage to and clogging of objects being conveyed.





# Cardboard Box Making Machines

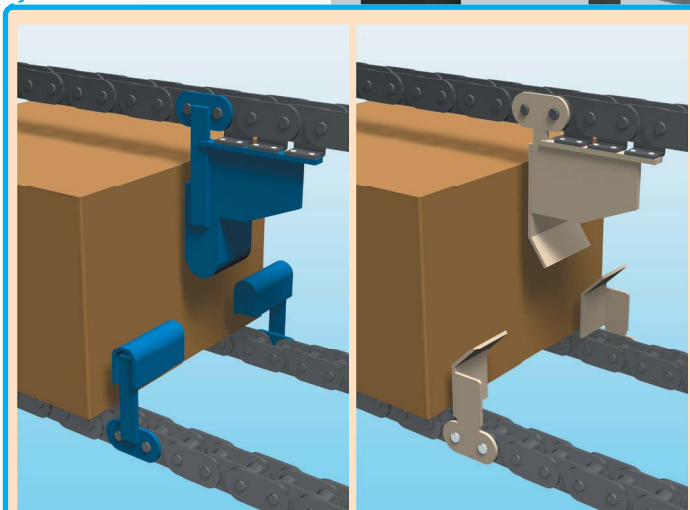
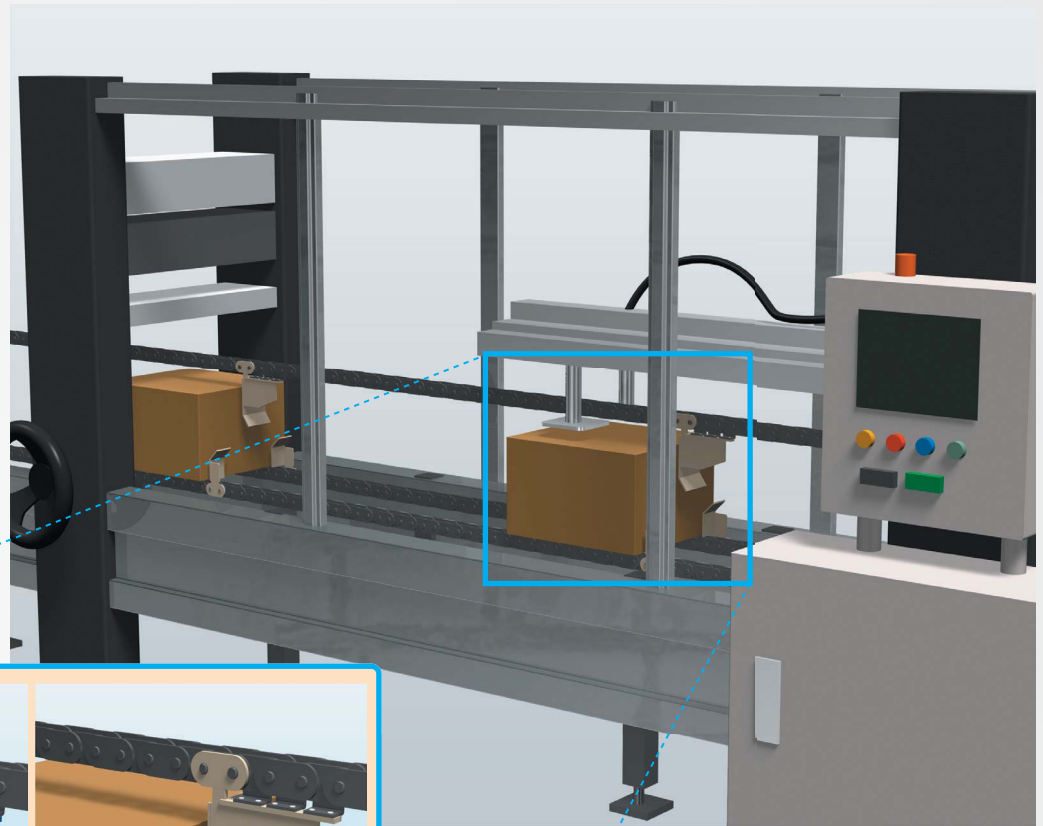
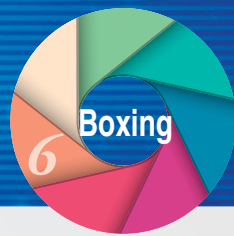

Conventional specifications  
Welded and bolt fastened

Integrated specifications  
Integrated bending type

## Small Size Conveyor Chain — Integrated Attachment Chain

This product integrates the chain and attachments necessary for product transport to efficiently reduce cost, time, and labor.



# Other Products

## Linear Motion

Tsubaki linear motion products maximize the features of the Zip Chain and screw jack mechanisms and cover the optimal capacity range. Select the linear motion mechanism that best suits your equipment.

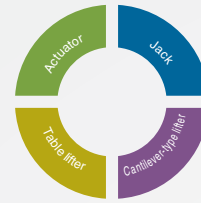

Choose the optimal Tsubaki linear motion product.

### Actuator range

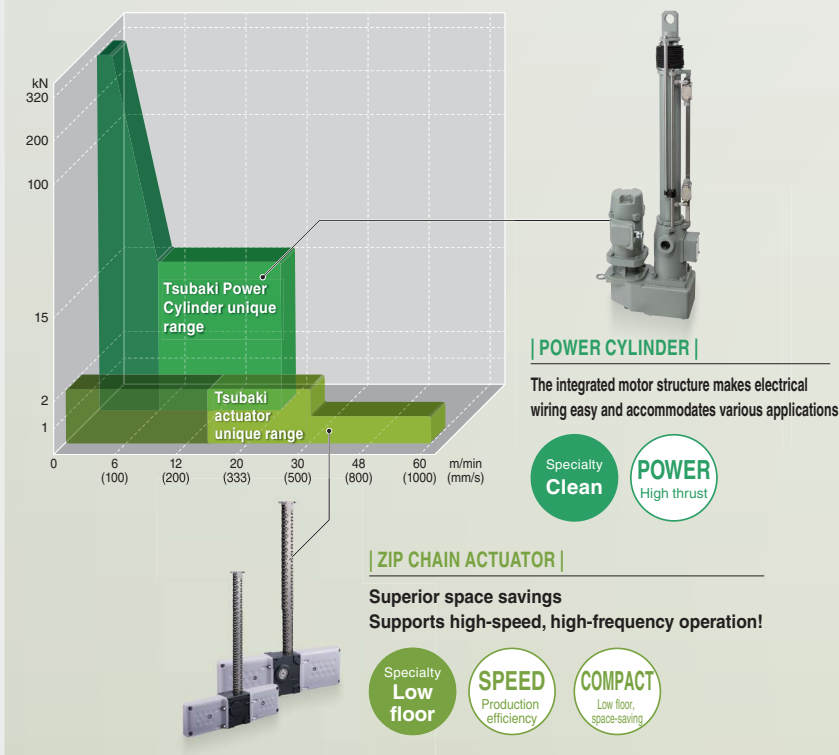

### Jack range

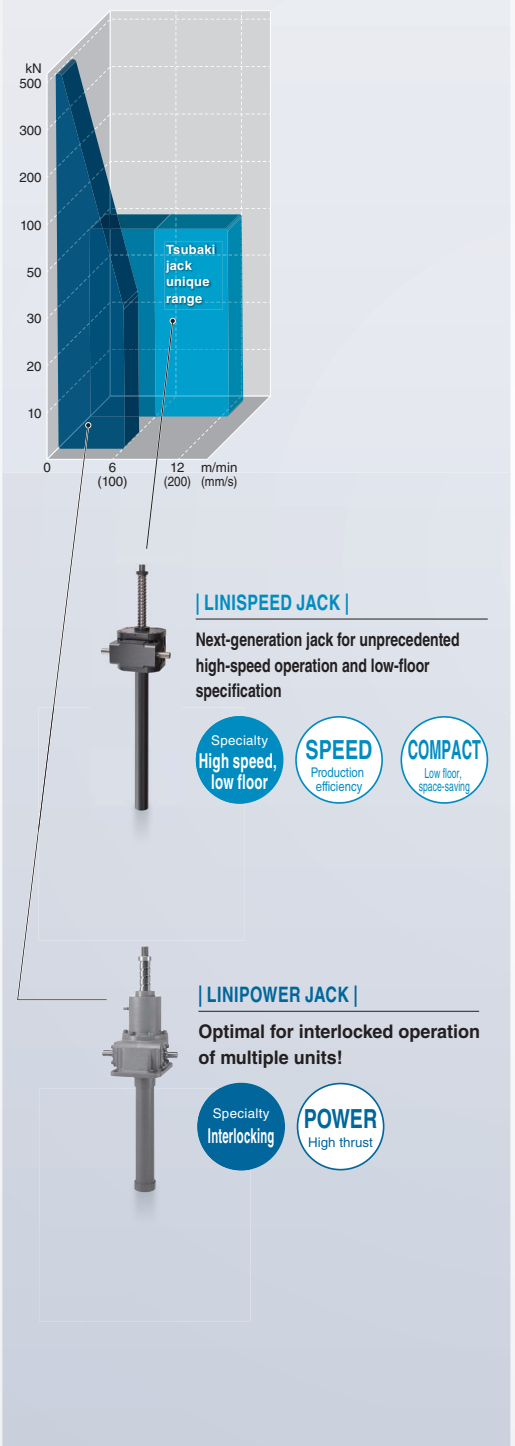

### Table lifter range

### Cantilever-type lifter range

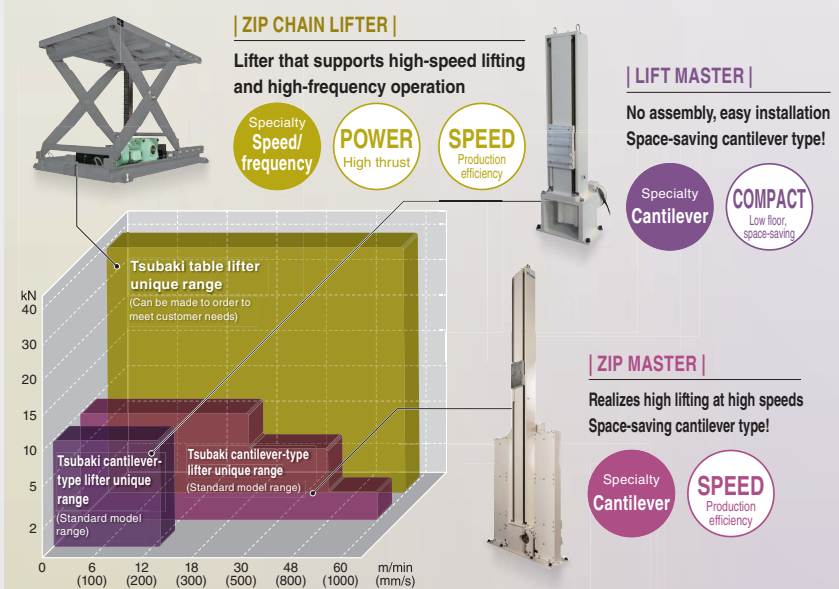

# WinCS mini

## Features

- ▶ Standardized specs enable rapid delivery.
- ▶ The knife edge construction enables smooth transferring even for small objects.
- ▶ Ideal for accumulating objects being conveyed.
- ▶ Enables horizontal sliding of conveyed objects on the conveyor.
- ▶ No damage to the chain due to meandering.
- ▶ Sprocket drive prevents slipping, unlike friction drive.
- ▶ Just select the model to order.

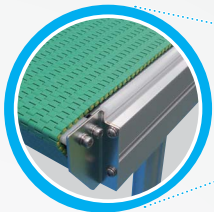

### Meandering prevention guide

Both sides of the chain provide a guide, preventing meandering.

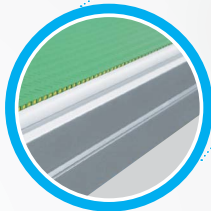

### Free slot

Easy mounting of guide and sensor legs.

\* Supports post-insertion of dedicated nut (order separately)

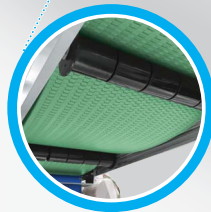

### Compact design

Return roller and chain can be stored inside the aluminum frame.

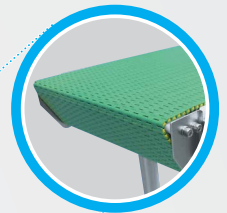

### Conveyor end shape

Nose bar system

\* The conveyor end has a knife edge construction that enables smooth transferring.

### Motor



Hollow hypoid motor 90 W

\* You can specify the mounting side.

\* Photo is for reference only.

Legs are not included with the conveyor main unit and must be ordered separately.

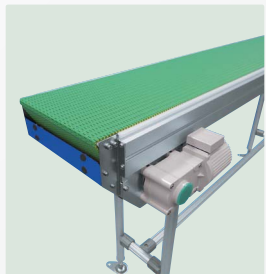
## Comparison of WinCS mini and belt conveyor

	WinCS mini	Belt conveyor
		
Belt (chain) replacement	Easy to connect and replace chain, and partial repair possible if damaged.	Endless design requires complete replacement of belt. Takes time to replace.
Maintenance	No tension adjustment or periodic shortening of chain required.	Tension must be adjusted or slipping will occur.
Damage to conveyed objects	Plastic chain has good lubrication to prevent damage to objects being conveyed.	Poor lubrication and not suitable for accumulation transport.
Drive	Uses sprockets for reliable drive operation.	Friction drive can cause slipping.
Meandering prevention	Sprocket drive prevents meandering. Meandering prevention guide ensures stable transport.	Pulley tension adjustment is difficult to perform, and meandering is likely to occur. Meandering can cause fraying of the belt end.
Cleanliness	Plastic Modular Chain is washable. Made completely of plastic for disposal without having to separate it.	Difficult to remove to wash.
Service life	Supports high-strength, high-load long conveyors, and features a durable design for longer life.	Short service life due to rubbing with products.

## Plastic Modular Chain

WT0705 and WT1515 Series are used for **reliable, product-friendly transport.**

**WT0705-W Series** | 7.5-mm pitch (1% open area)

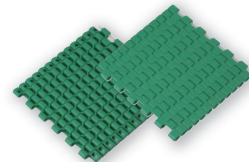

**WT1515-W / WT1516-W Series** | 15-mm pitch

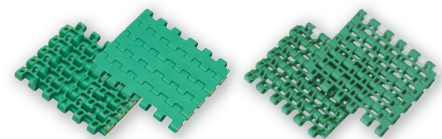

WT1515-W Series (2% open area)

WT1516-W Series (25% open area)

### | Chain width |

50 mm, 100 mm, 150 mm, 200 mm, 250 mm, 300 mm (contact us for widths of 350 mm or more)

Select the chain width in increments of 50 mm (standard configuration). Can be easily replaced from a flat belt conveyor.

### | Meandering prevention |

The stable drive due to the use of sprockets and guiding of the chain on both sides eliminate the possibility of meandering that occurs with belt conveyors.





## TSUBAKIMOTO CHAIN CO.

Japan	Headquarters	+81 6-6441-0011	<a href="https://tsubakimoto.com/">https://tsubakimoto.com/</a>
-------	--------------	-----------------	---

### Global Group Companies

#### AMERICAS

United States of America	U.S. Tsubaki Power Transmission, LLC	+1 847-459-9500	<a href="https://www.ustsubaki.com/">https://www.ustsubaki.com/</a>
Brazil	Tsubaki Brasil Equipamentos Industriais Ltda.	+55 11-3253-5656	<a href="http://tsubaki.ind.br/">http://tsubaki.ind.br/</a>
Canada	Tsubaki of Canada Limited	+1 905-676-0400	<a href="http://tsubaki.ca/">http://tsubaki.ca/</a>

#### EUROPE

Netherlands	Tsubakimoto Europe B.V.	+31 78-6204000	<a href="https://tsubaki.eu/">https://tsubaki.eu/</a>
France	Kabelschlepp France S.A.R.L.	+33 1-34846365	<a href="https://kabelschlepp.fr/">https://kabelschlepp.fr/</a>
Germany	Tsubaki Deutschland GmbH	+49 89-2000-133-80	<a href="http://tsubaki.de/">http://tsubaki.de/</a>
	Tsubaki Kabelschlepp GmbH	+49 2762-4003-0	<a href="https://tsubaki-kabelschlepp.com/">https://tsubaki-kabelschlepp.com/</a>
Italy	Kabelschlepp Italia S.R.L.	+39 0331-350962	<a href="https://kabelschlepp.it/">https://kabelschlepp.it/</a>
Russia	OOO Tsubaki Kabelschlepp	+7 499-4180212	<a href="http://kabelschlepp.ru/">http://kabelschlepp.ru/</a>
Spain	Tsubaki Ibérica Power Transmission S.L.	+34 911-873450	<a href="http://tsubaki.es/">http://tsubaki.es/</a>
United Kingdom	Tsubakimoto U.K. Ltd.	+44 1623-688-700	<a href="https://tsubaki.eu/">https://tsubaki.eu/</a>

#### INDIAN OCEAN RIM

Singapore	Tsubakimoto Singapore Pte. Ltd.	+65 6861-0422/3/4	<a href="http://tsubaki.sg/">http://tsubaki.sg/</a>
Australia	Tsubaki Australia Pty. Limited	+61 2-9704-2500	<a href="http://tsubaki.com.au/">http://tsubaki.com.au/</a>
India	Tsubaki India Power Transmission Private Limited	+91 44-7101-2000	<a href="http://tsubaki.in/">http://tsubaki.in/</a>
Indonesia	PT. Tsubaki Indonesia Trading	+62 21-89458898	<a href="http://tsubakimoto.co.id/">http://tsubakimoto.co.id/</a>
Malaysia	Tsubaki Power Transmission (Malaysia) Sdn. Bhd.	+60 3-8966-2020	<a href="http://tsubaki.my/">http://tsubaki.my/</a>
New Zealand	Tsubaki Australia Pty. Limited - New Zealand Branch	+64 9-352-2085	<a href="http://tsubaki.com.au/">http://tsubaki.com.au/</a>
Philippines	Tsubakimoto Philippines Corporation	+63 2-8824-7519	<a href="http://tsubaki.ph/">http://tsubaki.ph/</a>
Thailand	Tsubakimoto (Thailand) Co., Ltd.	+66 2-262-0667/8/9	<a href="http://tsubaki.co.th/">http://tsubaki.co.th/</a>
Vietnam	Tsubakimoto Vietnam Co., Ltd.	+84 24-6274-1449	<a href="http://tsubaki.net.vn/">http://tsubaki.net.vn/</a>

#### EAST ASIA

Korea	Tsubakimoto Korea Co., Ltd.	+82 2-2183-0311	<a href="http://tsubakimoto-tck.co.kr/">http://tsubakimoto-tck.co.kr/</a>
Taiwan	Taiwan Tsubakimoto Co.	+886 3-3293827	<a href="https://tsubakimoto.tw/">https://tsubakimoto.tw/</a>

#### CHINA

China	Tsubakimoto Chain (Shanghai) Co., Ltd.	+86 21-53966651/2	<a href="http://tsubaki-sh.cn/">http://tsubaki-sh.cn/</a>
-------	--	-------------------	---



The Tsubaki Eco Link logo is used only on products that satisfy the standards for environmental friendliness set by the Tsubaki Group.

Distributed by: